

# M661/662 Crib Parts Identification Sheet

DO NOT assemble crib if parts and hardware are defective or missing.  
Contact AFG for exchange or keep the original box for return authorization.

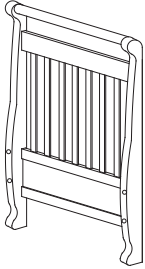

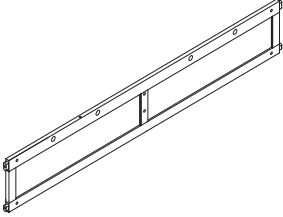

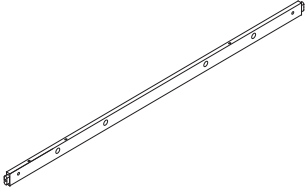
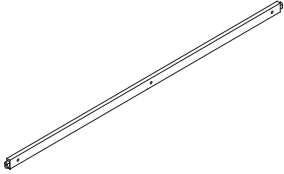
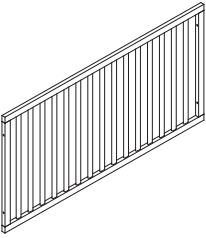
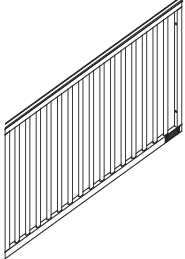
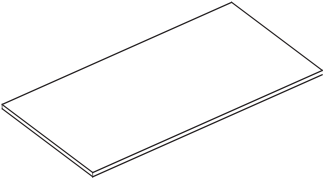
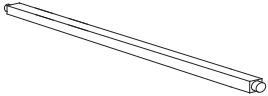
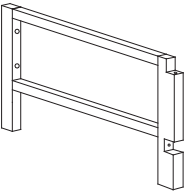
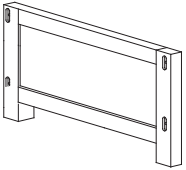
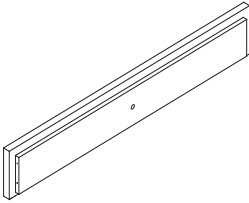
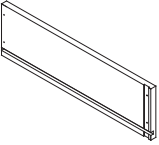
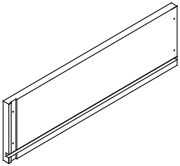
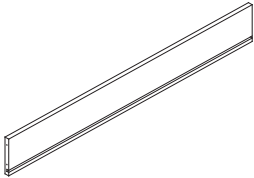
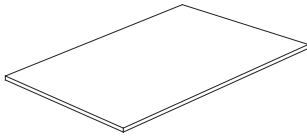

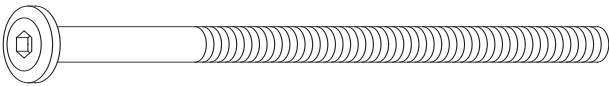
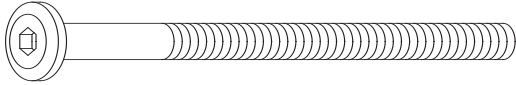
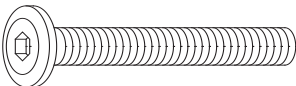

## ~ Crib Assembly Parts ~

<p>A. Headboard (1 pc)</p> 	<p>B. Fixed Side Bottom Panel (1 pc)</p> 	<p>C. Front Top Rail (1 pc)</p> 	<p>D. Front Bottom Rail (1 pc)</p> 
<p>E. Back Panel (1 pc)</p> 	<p>F. Front Panel (1 pc)</p> 	<p>G. Mattress Support Board (1 pc)</p> 	<p>H. Mattress Crossbar (4 pcs)</p> 
<p>I. Middle Side Panel (1 pc)</p> 	<p>J. Foot Board Bottom (1 pc)</p> 	<p>K. Drawer Front (2 pcs)</p> 	<p>L. Drawer Left Side (2 pcs)</p> 
<p>M. Drawer Right Side (2 pcs)</p> 	<p>N. Drawer Back (2 pcs)</p> 	<p>O. Drawer Bottom (2 pcs)</p> 	

# M661/662 Hardware Identification Sheet

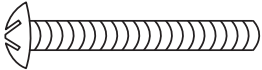
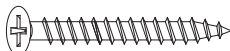
DO NOT assemble crib if parts and hardware are defective or missing.  
Contact AFG for exchange or keep the original box for return authorization.

## ~ Crib Assembly Hardware ~

Item #	Fittings	Qty
1. Bolt 1/4" x 3"		(6 pcs)
2. Bolt 1/4" x 2-1/2"		(4 pcs)
3. Bolt 1/4" x 1-1/4"		(3 pcs)
4. Bolt 1/4" x 2-1/4"		(4 pcs)
5. Wood Dowel 8 mm x 20 mm		(2 pcs)
6. Nut 1/4" x 15 mm		(8 pcs)
7. Handle		(2 pcs)
8. Bolt 5/32" x 1-1/4"		(2 pcs)
9. Screw F4 x 1"		(16 pcs)
10. Wrench		(1 pc)
11. Bolt 1/4" x 1-3/4"		(4 pcs)
12. Wood Dowel 10 mm x 30 mm		(4 pcs)
13. Security Bracket		(2 pcs)

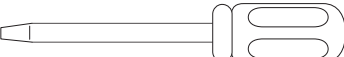

PHILLIPS SCREWDRIVER   (NOT INCLUDED)

FLATHEAD SCREWDRIVER   (NOT INCLUDED)

# M661/662 Changer Parts Identification Sheet

DO NOT assemble crib if parts and hardware are defective or missing.  
Contact AFG for exchange or keep the original box for return authorization.

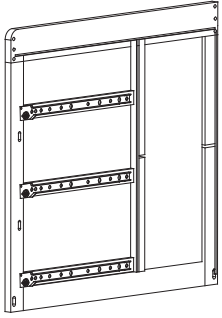
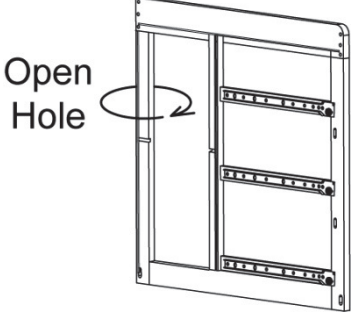
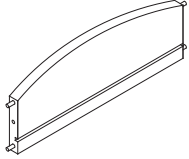
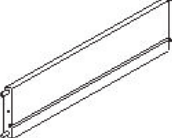
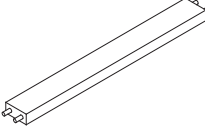
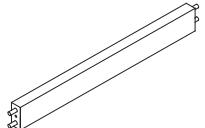
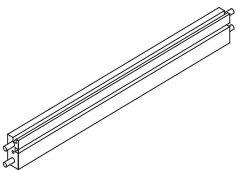
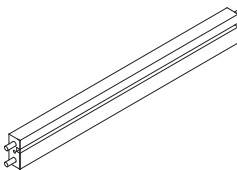
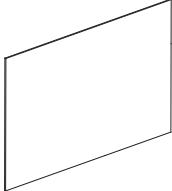
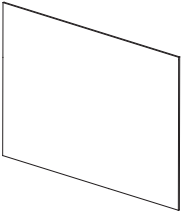
## ~ Changer Assembly Parts ~

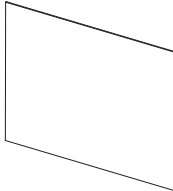
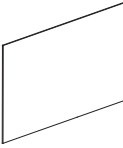
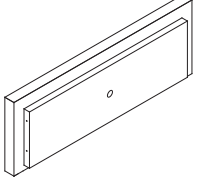
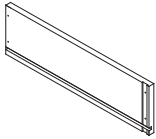
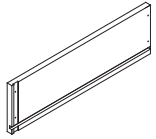
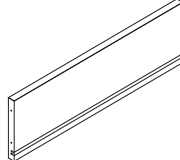
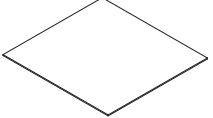
<p>A1. Left Panel (1 pc)</p> 		<p>A2. Right Panel (1 pc)</p> 	
<p>A3. Top Back Panel (1 pc)</p> 	<p>A4. Top Support Bar (1 pc)</p> 	<p>A5. Middle Support Bar (2 pcs)</p> 	<p>A6. Front Bottom Support Bar (1 pc)</p> 
<p>A7. Middle Bottom Support Bar (1 pc)</p> 	<p>A8. Back Bottom Support Bar (1 pc)</p> 	<p>A9. Dresser Top (1 pc)</p> 	<p>A10. Dresser Back Panel (1 pc)</p> 
<p>A11. Shelf Bottom (1 pc)</p> 	<p>A12. Dresser Middle (1 pc)</p> 	<p>A13. Shelf (1 pcs)</p> 	<p>A14. Drawer Front (3 pcs)</p> 
<p>A15. Drawer Left (3 pcs)</p> 	<p>A16. Drawer Right (3 pcs)</p> 	<p>A17. Drawer Back (3 pcs)</p> 	<p>A18. Drawer Bottom (3 pcs)</p> 

# M661/662 Hardware Identification Sheet

DO NOT assemble crib if parts and hardware are defective or missing.  
Contact AFG for exchange or keep the original box for return authorization.

## ~ Changer Assembly Hardware ~

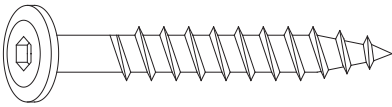
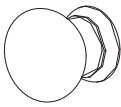
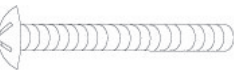
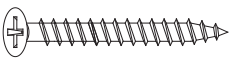
Item #	Fittings	Qty
S1. Screw 1/4" x 2"		(10 pcs)
S2. Handle		(3 pcs)
S3. Bolt 1/4" x 2-1/4"		(4 pcs)
S4. Screw F4 x 1"		(24 pcs)

PHILLIPS SCREWDRIVER  (NOT INCLUDED)